

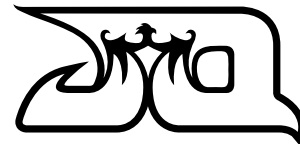

Name \_\_\_\_\_  
 Date \_\_\_\_\_  
 Track \_\_\_\_\_  
 Weather & Temp \_\_\_\_\_  
 Driver Mood \_\_\_\_\_

- Tight**    **Low Grip**
- Medium**    **Medium Grip**
- Open**    **High Grip**
- Smooth**    **Dusty**
- Rough**    **BlueGroove**



### FRONT

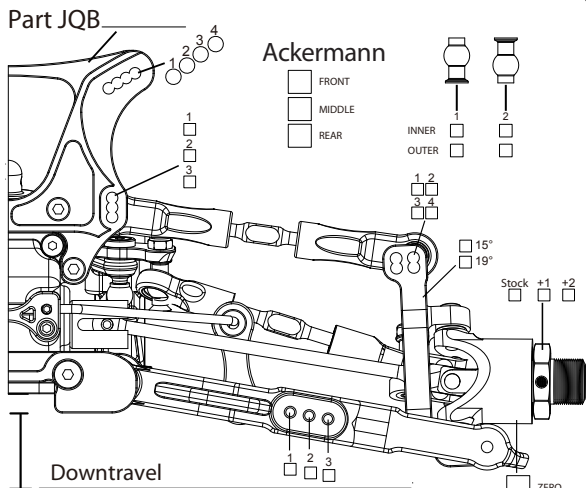

### Kick-up

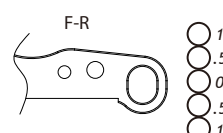
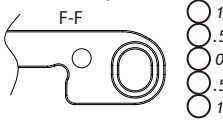

### Antisquat

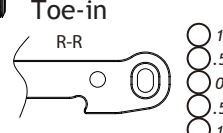
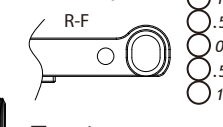

- ZERO
- KPI#1
- HIGH
- STOCK

- 2.5
- 2.75
- 3
- 3.25

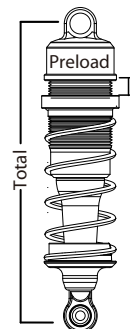

- R-F
- +2 HIGH
  - LOW
- R-R
- +2 HIGH
  - LOW

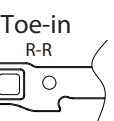

### DEGREES

	3.5	3	2.5	2	1.5
○	○	○	○	○	○
○	○	○	○	○	○
○	○	○	○	○	○
○	○	○	○	○	○
○	○	○	○	○	○

○	○	○	○	○	○
○	○	○	○	○	○
○	○	○	○	○	○
○	○	○	○	○	○
○	○	○	○	○	○
○	○	○	○	○	○

### REAR

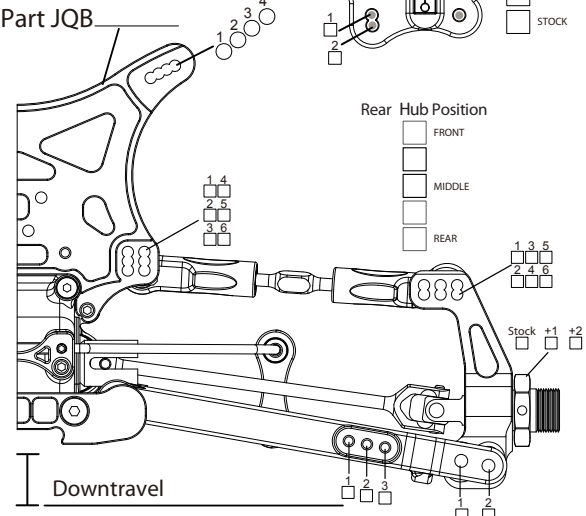

- Chassis
- 3mm
  - 4mm

Part JQB \_\_\_\_\_

Car Weight \_\_\_\_\_ **g**

Engine	Plug	Fuel
Pipe	Clutch	Clutch Spring

### NOTES

\_\_\_\_\_

\_\_\_\_\_

\_\_\_\_\_

\_\_\_\_\_

\_\_\_\_\_

Best Lapt ime
Runtime
Best result
Qualifying Position
Final Position

	FRONT	REAR
<b>*</b>		
Ride Height		
Downtravel With Tyres		
Swaybar		
Brake Balance	%	%
Camber	Length: _____ mm Degree: _____	Length: _____ mm Degree: _____
Steering Link / Front Toe	Length: _____ mm Degree: _____	

SHOCKS		
Oil wt / Brand		
Piston		
Spring		
Length	Preload: _____ mm	Preload: _____ mm
	Total: _____ mm	Total: _____ mm
Rebound		

TYRES		
Tread / Brand		
Compound		
Insert		
Wheel		
Tyre Set Weight		<b>g</b>

DIFFS			
	FRONT	CENTER	REAR
Oil wt / Brand			
Gear ratio (main/pinion)			